



BLUE collection

INFO TECNICHE pag. 309

TABELLA PREZZI FINITURE pag. 310



CONSULTA LISTINO ON LINE
CHECK ON LINE PRICE LIST

www.bellostarubinetterie.com/online/17_babys.pdf

INDICE | INDEX

LAVABO	pag. 311/314
BIDET	pag. 314/315
DOCCIA INCASSO	pag. 315/316
DEVIATORI INCASSO	pag. 316/317
DOCCIA INCASSO TERMOSTATICO	pag. 317/318
DOCCIA ESTERNO	pag. 318/319
DOCCIA ESTERNO TERMOSTATICO	pag. 319/320
DOCCIA COMPLEMENTI	pag. 320
SOFFIONI/BRACCI	pag. 320
COMPONI SET DOCCIA	pag. 320
VASCA	pag. 321/322
BAGNO COMPLEMENTI	pag. 322/323
RICAMBI	324

FORATURA DEI PIANI SANITARI

I miscelatori lavabo/bidet monoforo prevedono un foro di diametro 35 mm nel piano sanitario.

MONOFORO >>

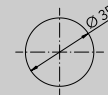

DRILLING PLANS HEALTH

The sink / hole bidet mixers provide a hole diameter of 35 mm in the health plan.



BABY S

INSTALLAZIONE LAVABI A MURO

Distanza verticale consigliata tra l'uscita dell'acqua ed il bordo superiore del lavabo 8÷10 cm.

WALL-MOUNTED WASHBASIN INSTALLATION

Recommended vertical distance between the water outlet and the upper edge of the sink 8÷10 cm.

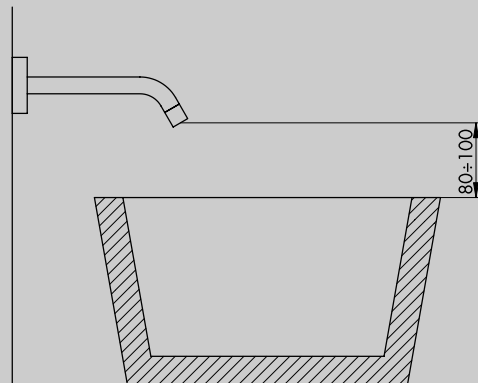

SCHEMA FUNZIONAMENTO DEVIATORI INCASSO 2/3/4 USCITE

Questi deviatori non hanno funzione di chiusura. Ruotando verso destra o sinistra si attivano le uscite. Tra 2 uscite adiacenti durante la rotazione diminuisce la portata dell'uscita iniziale ed incrementa quella della successiva. In posizione intermedia sono entrambe attive a pari portata.

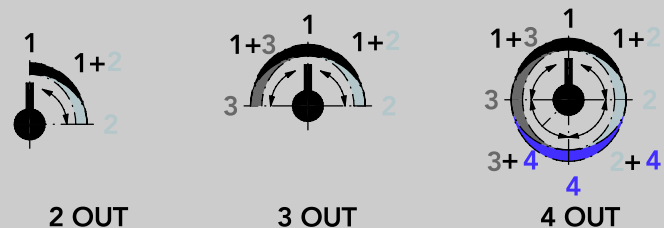

SCHEME OPERATION SWITCHES FLUSH OUTPUT 2/3/4

These diverters have not closing function. By turning to the right or left activates the outputs. Between two adjacent outputs during the rotation decreases the initial output flow and increases that of the next. In position intermediate are both active at the same flow rate.

SCHEMA FUNZIONAMENTO MISCELATORI TERMOSTATICI 2/3/4 USCITE

Leva in posizione ore 12 = deviatore chiuso. Ruotando verso destra o sinistra si attivano le diverse uscite. Partendo dalla posizione di STOP, durante la rotazione la portata dell'acqua si incrementa verso la posizione successiva. Tra 2 uscite adiacenti durante la rotazione diminuisce la portata dell'uscita iniziale ed incrementa quella della successiva. In posizione intermedia sono entrambe attive a pari portata.

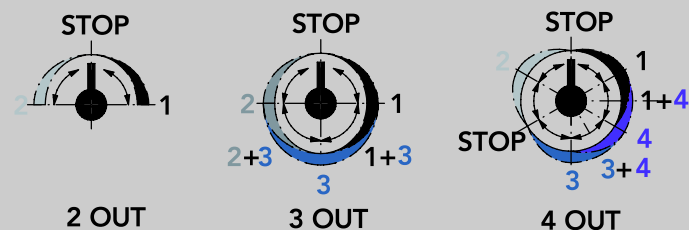

SCHEME OPERATING THERMOSTATIC MIXER 2/3/4 OUT

Lever to the 12 o'clock position = switch closed. Turning left or right. They activate different outputs. Starting from the STOP position, while rotation of the water flow rate between two adjacent outputs is increased towards the next position. Between two adjacent outputs during the rotation decreases the initial output flow and increases that of the next. In position intermediate are both active at the same flow rate.

CONSIGLIO TECNICO

Tutti i miscelatori della collezione BABY S vengono collaudati nel loro funzionamento al momento dell'assemblaggio. Per garantire la durata delle cartucce nel tempo, si consiglia di spurgare bene l'impianto idraulico prima del montaggio (per rimuovere eventuali detriti) e di installare rubinetti sottolavabo con filtro (art. 020)

N.B.: Qualora il piano lavabo avesse uno spessore superiore a 5 cm specificare la misura al momento dell'ordine.

TECHNICAL ADVICE

All mixers of the BABY S collection are perfectly tested. To guarantee the perfect functionality of the cartridge for a long time, we advise to clean the sanitary plant before installing the mixer. Moreover we advise to install angle valve with filter (art. 020).

Attention: If the lavatory top is more than cm 5 thick, please point it out when placing the order.

PROGETTO SU MISURA: RICHIESTE SPECIALI

I tecnici di Bellosta Rubinetterie sono, inoltre, a disposizione di architetti e designers, per offrire un servizio esclusivo: personalizzazioni di elementi in funzione di specifiche richieste estetiche o problematiche legate a vincoli progettuali, verifica della fattibilità attraverso opportuni studi CAD e sviluppo del disegno tecnico del prodotto speciale richiesto.

Per informazioni e richieste PROGETTI SU MISURA:

ufficiotecnico@bellostarubinetterie.com

PROGETTO SU MISURA: SPECIAL REQUESTS

Engineers Bellosta Rubinetterie are also available to architects and designers, to offer an exclusive service: customizations of items according to specific aesthetic requirements or issues related to design constraints, verification of the feasibility studies and development through appropriate CAD technical design the required special product. For information and requests "SU MISURA" PROJECTS:

ufficiotecnico@bellostarubinetterie.com

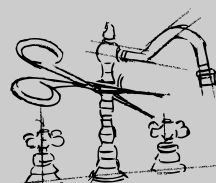

progetto

"SUMISURA"

TABELLA PREZZI FINITURE

PREZZO FINITURE

Calcola il prezzo di listino (IVA esclusa) delle finiture diverse dal cromato, consultando la seguente tabella.

Moltiplicare il PREZZO LISTINO per il COEFFICIENTE MOLTIPLICATORE della finitura scelta, arrotondando per difetto il prezzo ottenuto (eliminare i centesimi).
ESEMPIO per ordinare art. 7205 in finitura dorato: codice 04-7205

PRICE FINISHES

Include the list price (excluding VAT) of different finishes from chrome, consulting the following table. Multiply the PRICE LIST MULTIPLIER COEFFICIENT of the chosen finish, reducing the price obtained by deleting the centesim.

EXAMPLE to order art. 7205 gold finish: code 04-7205

COMPOSIZIONE CODICE PER ORDINARE ARTICOLO IN FINITURA

XX - 7205

CODICE FINITURA
FINISH CODE

CODICE ARTICOLO
ITEM NUMBER

MOLTIPLICATORI FINITURE DI SERIE
STANDARD FINISHES MULTIPLIERS

COD. CODE	DESCRIZIONE FINITURA FINISH DESCRIPTION	BABY S	RICAMBI	DOCCIA COMPL.
01-	cromato/chrome	PREZZO LISTINO°		
33-	cromo satinato/satin chrome			
34-	cromo spazzolato/brushing chrome			
35-	nickel spazzolato/brushing nickel			
66-	bianco opaco/mat white			
75-	dorato spazzolato/brushing gold			

MOLTIPLICATORI FINITURE A RICHIESTA
ON REQUEST FINISHES MULTIPLIERS

COD. CODE	DESCRIZIONE FINITURA FINISH DESCRIPTION	BABY S	RICAMBI	DOCCIA COMPL.
02-	cromo/oro/chrome/gold			
03-	oro/argento/gold/silver			
04-	dorato/gold			
05-	bronzo satinato/satin bronze			
06-	rame vecchio/old copper			
07-	vecchio argento/old silver			
08-	canna di fucile/gun barrel			
10-	verderame/verdigris			
11-	nero antracite/anthracite black			
12-	ottone lucido/polished brass			
13-	ottone naturale/natural brass			
14-	bianco lucido/glossy white			
19-	nero lucido/glossy black			
28-	nickel satinato/satin nickel			
30-	nickel lucido/polished nickel			
56-	avorio/ivory			

MOLTIPLICATORI FINITURE A RICHIESTA
ON REQUEST FINISHES MULTIPLIERS

COD. CODE	DESCRIZIONE FINITURA FINISH DESCRIPTION	BABY S	RICAMBI	DOCCIA COMPL.
57-	azzurro/light blue			
58-	verdino/light green			
59-	marrone/brown			
60-	arancio/orange			
61-	rosso/red			
67-	nero opaco/matt black			
68-	rame opaco/matt copper			
69-	argento opaco/matt silver			
71-	oro opaco/matt gold			
72-	bronzo opaco/matt bronze			
87-	oro rosa/pink gold			
88-	ottone sisal/sisal brass			
89-	industrial			
92-	pomice opaco/matt pumice			
93-	arenaria opaco/matt sandstone			
94-	tuscany spazzolato/brushing tuscany			
95-	rame acidato/etched copper			
96-	cemento opaco/matt cement			
A1-	brina opaco/matt frost			
A2-	tuscany cerato/oilskin tuscany			
A3-	ottone acidato/etched brass			
A4-	basalto opaco/matt basalt			
B2-	black gun metal PVD			
B3-	nickel PVD			
B4-	matt gold PVD			

°PREZZO DI LISTINO PRICE LIST
RICAMBI SPARE PARTS

* N.R. = NON REALIZZABILE NOT MADE
DOCCIA COMPLEMENTI SHOWER COMPLEMENTS

RICH. = PREZZO A RICHIESTA ON REQUEST PRICE

NOTE:

Flex art. 915003 realizzabile nelle seguenti finiture:
01,03,04,05,06,07,12,13,19,28,30,33,34,35,66,67,68,69,71,72,75,B2,B3,B4.
Per altre finiture ordinare art. 655016.

NOTE:

Flex art. 915003 is available in the following finishes:
01,03,04,05,06,07,12,13,19,28,30,33,34,35,66,67,68,69,71,72,75,B2,B3,B4.
For other colors order the art. 655016.

7205

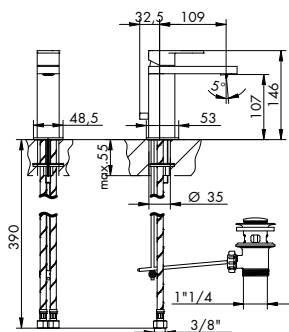
MISCELATORE LAVABO MONOFORO
BASIN MIXER

- > cartuccia tradizionale
- > interasse bocca 109
- > flessibili di alimentazione
- > con scarico
- > abbinare a rubinetto sottolavabo con filtro (art. 020)

SIFONE
SIPHON

0133/L p. 879

CROMATO

01-7205

€

ALTRE FINITURE

XX-7205

€

x M*

AERATORE C/CHIAVE
AERATOR W/KEY

725007

CARTUCCIA
CARTRIDGE

735005

7205/S

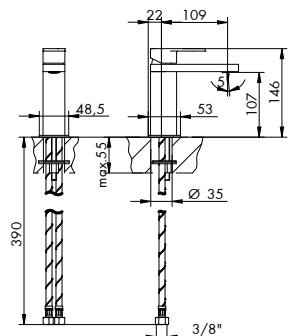
MISCELATORE LAVABO MONOFORO
BASIN MIXER

- > cartuccia tradizionale
- > interasse bocca 109
- > flessibili di alimentazione
- > senza scarico
- > abbinare a rubinetto sottolavabo con filtro (art. 020)

SCARICO LAVABO
BASIN VASTE

0136/U p. 880

SIFONE
SIPHON

0133/L p. 879

CROMATO

01-7205/S

€

ALTRE FINITURE

XX-7205/S

€

x M*

AERATORE C/CHIAVE
AERATOR W/KEY

725007

CARTUCCIA
CARTRIDGE

735005

7205/P

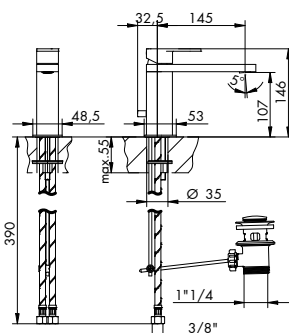
MISCELATORE LAVABO MONOFORO BOCCA PROLUNGATA
BASIN MIXER EXTENDED SPOUT

- > cartuccia tradizionale
- > interasse bocca 145
- > flessibili di alimentazione
- > con scarico
- > abbinare a rubinetto sottolavabo con filtro (art. 020)

SIFONE
SIPHON

0133/L p. 879

CROMATO

01-7205/P

€

ALTRE FINITURE

XX-7205/P

€

x M*

AERATORE C/CHIAVE
AERATOR W/KEY

725007

CARTUCCIA
CARTRIDGE

735005

7205/P/S

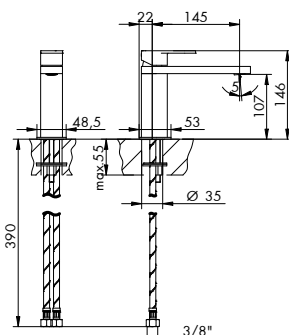
MISCELATORE LAVABO MONOFORO BOCCA PROLUNGATA
BASIN MIXER EXTENDED SPOUT

- > cartuccia tradizionale
- > interasse bocca 145
- > flessibili di alimentazione
- > senza scarico
- > abbinare a rubinetto sottolavabo con filtro (art. 020)

SCARICO LAVABO
BASIN VASTE

0136/U p. 880

SIFONE
SIPHON

0133/L p. 879

CROMATO

01-7205/P/S

€

ALTRE FINITURE

XX-7205/P/S

€

x M*

AERATORE C/CHIAVE
AERATOR W/KEY

725007

CARTUCCIA
CARTRIDGE

735005

7205/P/A

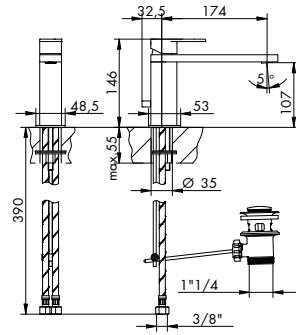

MISCELATORE LAVABO MONOFORO BOCCA EXTRAPROLUNGATA
BASIN MIXER EXTRA EXTENDED SPOUT

- > cartuccia tradizionale
- > interasse bocca 174
- > flessibili di alimentazione
- > con scarico
- > abbinare a rubinetto sottolavabo con filtro (art. 020)



0133/L p. 879

CROMATO		
01-7205/P/A	€	

ALTRE FINITURE		
XX-7205/P/A	€	x M*



725007



735005

7205/P/A/S

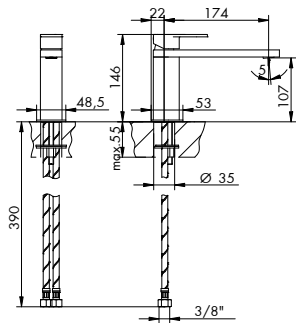

MISCELATORE LAVABO MONOFORO BOCCA EXTRAPROLUNGATA
BASIN MIXER EXTRA EXTENDED SPOUT

- > cartuccia tradizionale
- > interasse bocca 174
- > flessibili di alimentazione
- > senza scarico
- > abbinare a rubinetto sottolavabo con filtro (art. 020)



0136/U p. 880



0133/L p. 879

CROMATO		
01-7205/P/A/S	€	

ALTRE FINITURE		
XX-7205/P/A/S	€	x M*



725007



735005

724002 | 724003 | 724001



PROLUNGHE MISCELATORE LAVABO
EXTENSIONS FOR BASIN

- > altezza 100 mm, 150 mm, 180 mm

CROMATO		
01-724002	100 mm	€
01-724003	150 mm	€
01-724001	180 mm	€

ALTRE FINITURE		
XX-724002	100 mm	€ x M*
XX-724003	150 mm	€ x M*
XX-724001	180 mm	€ x M*

7205/3/A/E + 724008

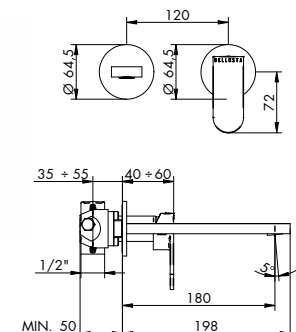

MISCELATORE LAVABO DA PARETE
WALL BASIN MIXER

- > cartuccia tradizionale
- > interasse bocca 180
- > ingressi da 1/2"
- > senza scarico



0136/U p. 880



0133/L p. 879

PARTI ESTERNE - CROMATO		
01-7205/3/A/E	€	

PARTI ESTERNE - ALTRE FINITURE		
XX-7205/3/A/E	€	x M*

PARTE INCASSO		
01-724008	info pag. 29	€

PREZZO TOTALE		
	€	



PER INSTALLAZIONI SU PARETI IN CARTONGESSO VERIFICARE LE DIMENSIONI DEL PANNELLO E ORDINARE LA NECESSARIA PROLUNGA
FOR INSTALLATIONS ON DRYWALL, CHECK THE DIMENSIONS OF THE PANEL AND ORDER THE NECESSARY EXTENSION



725007



444001

7205/3/B/E + 724008

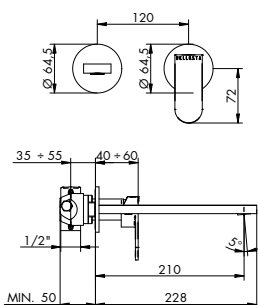

MISCELATORE LAVABO DA PARETE BOCCA PROLUNGATA

WALL BASIN MIXER EXTENDED SPOUT

- > cartuccia tradizionale
- > interasse bocca 210
- > ingressi da 1/2"
- > senza scarico



0136/U p. 880



0133/L p. 879

PARTI ESTERNE - CROMATO

01-7205/3/B/E €

PARTI ESTERNE - ALTRE FINITURE

XX-7205/3/B/E € x M*

PARTE INCASSO

01-724008 info pag. 29 €

PREZZO TOTALE €



PER INSTALLAZIONI SU PARETI IN CARTONGESSO VERIFICARE LE DIMENSIONI DEL PANNELLO E ORDINARE LA NECESSARIA PROLUNGA
FOR INSTALLATIONS ON DRYWALL, CHECK THE DIMENSIONS OF THE PANEL AND ORDER THE NECESSARY EXTENSION



725007



444021

7205/3/E + 724008

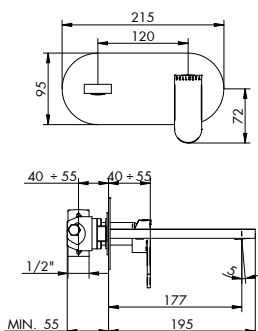

MISCELATORE LAVABO DA PARETE SU PIASTRA

WALL BASIN MIXER ON PLATE

- > cartuccia tradizionale
- > interasse bocca 177
- > ingressi da 1/2"
- > senza scarico



0136/U p. 880



0133/L p. 879

PARTI ESTERNE - CROMATO

01-7205/3/E €

PARTI ESTERNE - ALTRE FINITURE

XX-7205/3/E € x M*

PARTE INCASSO

01-724008 info pag. 29 €

PREZZO TOTALE €



PER INSTALLAZIONI SU PARETI IN CARTONGESSO VERIFICARE LE DIMENSIONI DEL PANNELLO E ORDINARE LA NECESSARIA PROLUNGA
FOR INSTALLATIONS ON DRYWALL, CHECK THE DIMENSIONS OF THE PANEL AND ORDER THE NECESSARY EXTENSION



725007



444021

7205/3/1/E + 724008

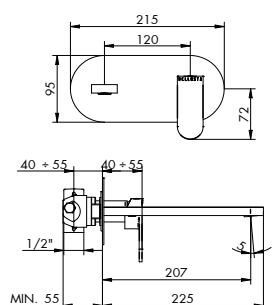

MISCELATORE LAVABO DA PARETE BOCCA PROLUNGATA SU PIASTRA

WALL BASIN MIXER EXTENDED SPOUT ON PLATE

- > cartuccia tradizionale
- > interasse bocca 207
- > ingressi da 1/2"
- > senza scarico



0136/U p. 880



0133/L p. 879

PARTI ESTERNE - CROMATO

01-7205/3/1/E €

PARTI ESTERNE - ALTRE FINITURE

XX-7205/3/1/E € x M*

PARTE INCASSO

01-724008 info pag. 29 €

PREZZO TOTALE €



PER INSTALLAZIONI SU PARETI IN CARTONGESSO VERIFICARE LE DIMENSIONI DEL PANNELLO E ORDINARE LA NECESSARIA PROLUNGA
FOR INSTALLATIONS ON DRYWALL, CHECK THE DIMENSIONS OF THE PANEL AND ORDER THE NECESSARY EXTENSION



725007



444021

7205/R/A

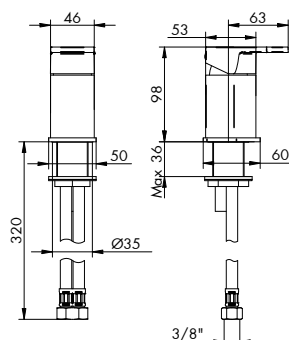

MISCELATORE REMOTO

REMOTE MIXER

- > cartuccia tradizionale
- > flessibili di alimentazione
- > senza scarico
- > abbinare a rubinetto sottolavabo con filtro (art. 020)



0136/U p. 880



0133/L p. 879

CROMATO

01-7205/R/A €

ALTRE FINITURE

XX-7205/R/A € x M*



025002

7205/R/B/E + 104033

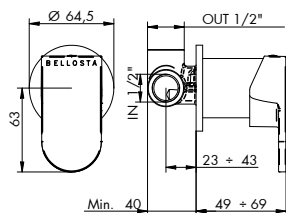

MISCELATORE INCASSO REMOTO

BUILT-IN REMOTE MIXER

- > cartuccia tradizionale
- > ingressi da 1/2"
- > uscita superiore
- > senza scarico
- > utilizzabile anche come incasso doccia



0136/U p. 880



0133/L p. 879

PARTI ESTERNE - CROMATO

01-7205/R/B/E €

PARTE INCASSO

01-104033 info pag. 27 €

PREZZO TOTALE €

PARTI ESTERNE - ALTRE FINITURE

XX-7205/R/B/E € x M*



PER INSTALLAZIONI SU PARETI IN CARTONGESSO VERIFICARE LE DIMENSIONI DEL PANNELLO E ORDINARE LA NECESSARIA PROLUNGA
FOR INSTALLATIONS ON DRYWALL, CHECK THE DIMENSIONS OF THE PANEL AND ORDER THE NECESSARY EXTENSION



025002

104009 | 104010 | 104011



KIT PROLUNGA MIX INCASSO

BUILT-IN MIXER EXTENSION KIT

- > lunghezza 2 cm, 3 cm, 4 cm
- > kit fondello prolunga cartuccia miscelatore + bicchiere esterno sostitutivo in finitura
- > per art. 7205/R/B/E

CROMATO

01-104009 2 cm €

01-104010 3 cm €

01-104011 4 cm €

ALTRE FINITURE

XX-104009 2 cm € x M*

XX-104010 3 cm € x M*

XX-104011 4 cm € x M*

* MOLTIPLICATORE RICAMBI

* MULTIPLIER "RICAMBI"

724009 | 724007

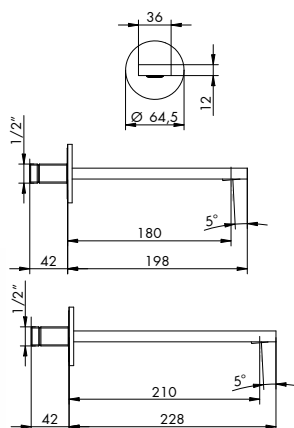

BOCCA LAVABO DA PARETE

WALL BASIN SPOUT

- > interasse bocca 180 / 210 mm
- > attacco da 1/2"



0136/U p. 880



0133/L p. 879

CROMATO

01-724009 180 mm €

01-724007 210 mm €

ALTRE FINITURE

XX-724009 180 mm € x M*

XX-724007 210 mm € x M*

* MOLTIPLICATORE RICAMBI

* MULTIPLIER "RICAMBI"



725007

7207

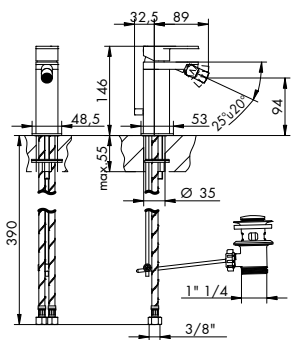

MISCELATORE BIDET MONOFORO

BIDET MIXER

- > cartuccia tradizionale
- > interasse bocca 89
- > aeratore snodato
- > flessibili di alimentazione
- > con scarico



011/B p. 887

CROMATO

01-7207 €

ALTRE FINITURE

XX-7207 € x M*



014076

01- cromato / XX- finitura



735005

7207/S

NEW

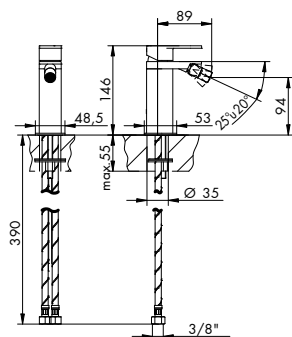

MISCELATORE BIDET MONOFORO

BIDET MIXER

- > cartuccia tradizionale
- > interasse bocca 89
- > aeratore snodato
- > flessibili di alimentazione
- > senza scarico



CROMATO	
01-7207/S	€

ALTRE FINITURE	
XX-7207/S	€ x M*

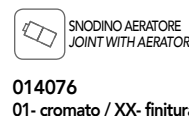

014076
01- cromo / XX- finitura

735005

7221/N/E + 104018

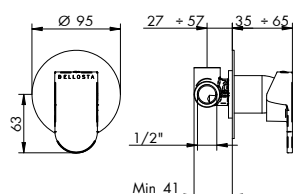

MISCELATORE INCASSO

BUILT-IN MIXER

- > cartuccia tradizionale
- > ingressi da 1/2"
- > uscita superiore
- > incasso con B-BOX



PARTI ESTERNE - CROMATO	
01-7221/N/E	€

PARTI ESTERNE - ALTRE FINITURE	
XX-7221/N/E	€ x M*

PARTE INCASSO	
01-104018	info pag. 32 €

PREZZO TOTALE	
	€

INCASSO UNIVERSALE CON B-BOX



PER INSTALLAZIONI SU PARETI IN CARTONGESSO VERIFICARE LE DIMENSIONI DEL PANNELLO E ORDINARE LA NECESSARIA PROLUNGA
FOR INSTALLATIONS ON DRYWALL, CHECK THE DIMENSIONS OF THE PANEL AND ORDER THE NECESSARY EXTENSION



025002

104009 | 104010 | 104011



KIT PROLUNGA MIX INCASSO

BUILT-IN MIXER EXTENSION KIT

- > lunghezza 2 cm, 3 cm, 4 cm
- > kit fondello prolunga cartuccia miscelatore + bicchiere esterno sostitutivo in finitura
- > per art.: 7221/N/E

CROMATO		
01-104009	2 cm	€
01-104010	3 cm	€
01-104011	4 cm	€

ALTRE FINITURE			
XX-104009	2 cm	€	x M*
XX-104010	3 cm	€	x M*
XX-104011	4 cm	€	x M*

* MOLTIPLICATORE RICAMBI
* MULTIPLIER "RICAMBI"

7200/E + 104002

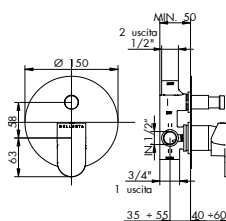

MISCELATORE INCASSO C/DEVIATORE AUTOMATICO 2 USCITE

BUILT-IN MIXER WITH AUTOMATIC DIVERTER 2 OUT

- > cartuccia tradizionale
- > deviatore a pressione 2 uscite c/ritorno automatico e blocco meccanico basse pressioni
- > attacchi da 1/2"
- > uscita principale inferiore da 3/4"
- > incasso con B-BOX



PARTI ESTERNE - CROMATO	
01-7200/E	€

PARTI ESTERNE - ALTRE FINITURE	
XX-7200/E	€ x M*

PARTE INCASSO	
01-104002	info pag. 33 €

PREZZO TOTALE	
	€

INCASSO UNIVERSALE CON B-BOX



PER INSTALLAZIONI SU PARETI IN CARTONGESSO VERIFICARE LE DIMENSIONI DEL PANNELLO E ORDINARE LA NECESSARIA PROLUNGA
FOR INSTALLATIONS ON DRYWALL, CHECK THE DIMENSIONS OF THE PANEL AND ORDER THE NECESSARY EXTENSION



105029

025002

7200/1/P/E + 724027

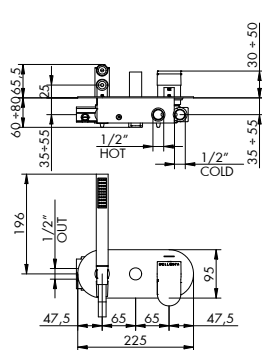

INCASSO
UNIVERSALE

MISCELATORE INCASSO C/DEVIATORE AUTOMATICO E DOCCETTA
BUILT-IN MIXER WITH AUTOMATIC DIVERTER AND HAND SHOWER

- > cartuccia tradizionale
- > deviatore a pressione 2 uscite c/ritorno automatico e blocco meccanico basse pressioni
- > attacchi da 1/2" > flessibile PVC 150 cm
- > uscita principale fianco sinistro
- > doccetta monogetto cilindrica in ABS c/anticalcare, per finiture diverse da cromo doccetta in metallo



PILETTA DOCCIA
SHOWER WASTE

8816/E + 775025
p. 888

PARTI ESTERNE - CROMATO

01-7200/1/P/E €

PARTI ESTERNE - ALTRE FINITURE

XX-7200/1/P/E € x M*

PARTE INCASSO

01-724027 info pag. 35 €

PREZZO TOTALE €

PER INSTALLAZIONI SU PARETI IN CARTONGESSO VERIFICARE LE DIMENSIONI DEL PANNELLO E ORDINARE LA NECESSARIA PROLUNGA
FOR INSTALLATIONS ON DRYWALL, CHECK THE DIMENSIONS OF THE PANEL AND ORDER THE NECESSARY EXTENSION



DEVIATORE
DIVERTER
724030



CARTUCCIA
CARTRIDGE
025002

104006 | 104007 | 104008



KIT PROLUNGA MIX INCASSO CON DEVIAZIONE
BUILT-IN MIXER EXTENSION KIT WITH DIVERTER

- > lunghezza 2 cm, 3 cm, 4 cm
- > kit fondello prolunga cartuccia miscelatore e albero deviatore + bicchieri esterni sostitutivi in finitura
- > per art.: 7200/E, 7200/1/P/E

CROMATO

01-104006 2 cm €

01-104007 3 cm €

01-104008 4 cm €

ALTRE FINITURE

XX-104006 2 cm € x M*

XX-104007 3 cm € x M*

XX-104008 4 cm € x M*

* MOLTIPLICATORE RICAMBI
* MULTIPLIER "RICAMBI"

7203/2/1/E + 914016

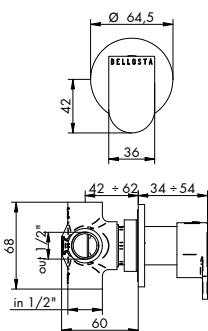

DEVIATORE INCASSO 2 USCITE
BUILT-IN DIVERTER 2 OUT

- > deviatore a dischi ceramici 2 uscite senza chiusura
- > attacchi da 1/2"
- > abbinare a miscelatore o rubinetti d'arresto

PARTI ESTERNE - CROMATO

01-7203/2/1/E €

PARTE INCASSO

914016 info pag. 36 €

PREZZO TOTALE €

PARTI ESTERNE - ALTRE FINITURE

XX-7203/2/1/E € x M*



CARTUCCIA
DEVIATRICE
DIVERTER CARTRIDGE



CARTUCCIA
DEVIATRICE
DIVERTER CARTRIDGE

035346 ante 9.2017 635010

7203/3/1/E + 034127

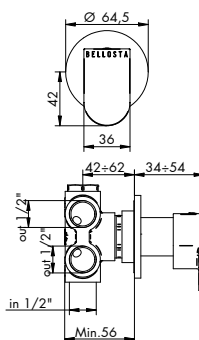

DEVIATORE INCASSO 3 USCITE
BUILT-IN DIVERTER 3 OUT

- > deviatore a dischi ceramici 3 uscite senza chiusura
- > attacchi da 1/2"
- > abbinare a miscelatore o rubinetti d'arresto

PARTI ESTERNE - CROMATO

01-7203/3/1/E €

PARTE INCASSO

034127 info pag. 36 €

PREZZO TOTALE €

PARTI ESTERNE - ALTRE FINITURE

XX-7203/3/1/E € x M*



CARTUCCIA
DEVIATRICE
DIVERTER CARTRIDGE



CARTUCCIA
DEVIATRICE
DIVERTER CARTRIDGE

035345 ante 9.2017 635011

7203/4/1/E + 034128

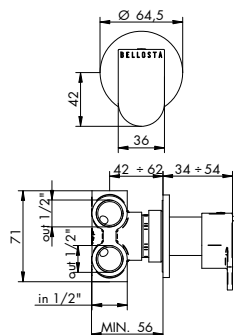

DEVIATORE INCASSO 4 USCITE
BUILT-IN DIVERTER 4 OUT

- > deviatore a dischi ceramici 4 uscite senza chiusura
- > attacchi da 1/2"
- > abbinare a miscelatore o rubinetti d'arresto

PARTI ESTERNE - CROMATO	
01-7203/4/1/E	€
PARTE INCASSO	
034128	info pag. 36 €
PREZZO TOTALE €	

PARTI ESTERNE - ALTRE FINITURE	
XX-7203/4/1/E	€ x M*



CARTUCCIA DEVIATRICE
DIVERTER CARTRIDGE



CARTUCCIA DEVIATRICE
DIVERTER CARTRIDGE

035344 ante 9.2017 635012

7212/P/E + 484020

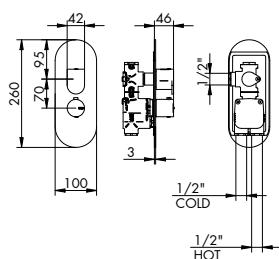

MISCELATORE TERMOSTATICO INCASSO 1 USCITA
BUILT-IN THERMOSTATIC MIXER 1 OUT

- > cartuccia termostatica
- > vitone ceramico 90°
- > apertura con rotazione antioraria
- > ingressi inferiori da 1/2"
- > incasso con B-BOX
- > posizionabile orizzontalmente
- > interasse 70 mm
- > uscite laterali destra da 1/2"
- > incasso regolabile min 76
- > piastra unica



PILETTA DOCCIA
SHOWER WASTE
8816/E + 775025
p. 888

PARTI ESTERNE - CROMATO	
01-7212/P/E	€
PARTE INCASSO	
484020	info pag. 37 €
PREZZO TOTALE €	

PARTI ESTERNE - ALTRE FINITURE	
XX-7212/P/E	€ x M*

INCASSO UNIVERSALE
CON B-BOX



PER INSTALLAZIONI SU PARETI IN CARTONGESSO VERIFICARE LE DIMENSIONI DEL PANNELLO E ORDINARE LA NECESSARIA PROLUNGA
FOR INSTALLATIONS ON DRYWALL, CHECK THE DIMENSIONS OF THE PANEL AND ORDER THE NECESSARY EXTENSION



VITONE CERAMICO
CERAMIC VALVE

055134



CART. TERMOSTATICA
THERMOSTATIC
CARTRIDGE

775007

7212/2/P/E + 484021

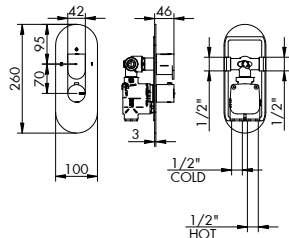

MISCELATORE TERMOSTATICO INCASSO C/ DEVIATORE 2 USCITE
BUILT-IN THERMOSTATIC MIXER WITH DIVERTER 2 OUT

- > cartuccia termostatica
- > deviatore a dischi ceramici 2 uscite c/chiusura
- > interasse 70 mm
- > ingressi inferiori da 1/2"
- > incasso con B-BOX
- > piastra unica
- > uscite laterali da 1/2"
- > incasso regolabile min 76



PILETTA DOCCIA
SHOWER WASTE
8816/E + 775025
p. 888

PARTI ESTERNE - CROMATO	
01-7212/2/P/E	€
PARTE INCASSO	
484021	info pag. 37 €
PREZZO TOTALE €	

PARTI ESTERNE - ALTRE FINITURE	
XX-7212/2/P/E	€ x M*

INCASSO UNIVERSALE
CON B-BOX



PER INSTALLAZIONI SU PARETI IN CARTONGESSO VERIFICARE LE DIMENSIONI DEL PANNELLO E ORDINARE LA NECESSARIA PROLUNGA
FOR INSTALLATIONS ON DRYWALL, CHECK THE DIMENSIONS OF THE PANEL AND ORDER THE NECESSARY EXTENSION



CARTUCCIA DEVIATRICE
DIVERTER CARTRIDGE

035346



CART. TERMOSTATICA
THERMOSTATIC
CARTRIDGE

775007

7212/3/P/E + 484022

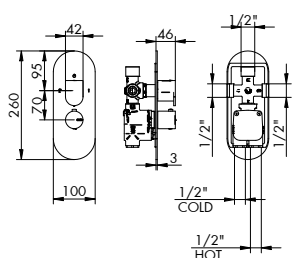

MISCELATORE TERMOSTATICO INCASSO C/DEVIATORE 3 USCITE
BUILT-IN THERMOSTATIC MIXER WITH DIVERTER 3 OUT

- > cartuccia termostatica
- > deviatore a dischi ceramici 3 uscite c/chiusura
- > interasse 70 mm
- > ingressi inferiori da 1/2"
- > incasso con B-BOX
- > piastra unica
- > uscite laterali e superiore da 1/2"
- > incasso regolabile min 76



PILETTA DOCCIA
SHOWER WASTE
8816/E + 775025
p. 888

PARTI ESTERNE - CROMATO	
01-7212/3/P/E	€
PARTE INCASSO	
484022	info pag. 37 €
PREZZO TOTALE €	

PARTI ESTERNE - ALTRE FINITURE	
XX-7212/3/P/E	€ x M*

INCASSO UNIVERSALE
CON B-BOX



PER INSTALLAZIONI SU PARETI IN CARTONGESSO VERIFICARE LE DIMENSIONI DEL PANNELLO E ORDINARE LA NECESSARIA PROLUNGA
FOR INSTALLATIONS ON DRYWALL, CHECK THE DIMENSIONS OF THE PANEL AND ORDER THE NECESSARY EXTENSION



CARTUCCIA DEVIATRICE
DIVERTER CARTRIDGE

035345



CART. TERMOSTATICA
THERMOSTATIC
CARTRIDGE

775007

7212/4/P/E + 484023

MISCELATORE TERMOSTATICO INCASSO C/DEVIATORE 4 USCITE
BUILT-IN THERMOSTATIC MIXER WITH DIVERTER 4 OUT

- > deviatore a dischi ceramici 4 uscite c/doppia chiusura
- > interasse 70 mm
- > ingressi inferiori da 1/2"
- > incasso in ottone con B-BOX
- > piastra unica
- > uscite laterali e superiore da 1/2"
- > incasso regolabile min 76

PILETTA DOCCIA
SHOWER WASTE
8816/E + 775025
p. 888

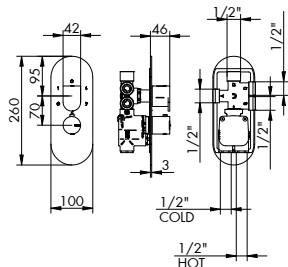

PARTI ESTERNE - CROMATO	
01-7212/4/P/E	€
PARTE INCASSO	
484023	info pag. 38 €
PREZZO TOTALE	
	€

PARTI ESTERNE - ALTRE FINITURE	
XX-7212/4/P/E	€ x M*

INCASSO
UNIVERSALE
CON B-BOX



PER INSTALLAZIONI SU PARETI IN CARTONGESSO VERIFICARE LE DIMENSIONI DEL PANNELLO E ORDINARE LA NECESSARIA PROLUNGA
FOR INSTALLATIONS ON DRYWALL, CHECK THE DIMENSIONS OF THE PANEL AND ORDER THE NECESSARY EXTENSION

CARTUCCIA
DEVIATRICE
DIVERTER CARTRIDGE
035344

CART. TERMOSTATICA
THERMOSTATIC
CARTRIDGE
775007

094021 | 094025

KIT PROLUNGA MIX INCASSO TERMOSTATICO
BUILT-IN THERMOSTATIC MIXER EXTENSION KIT

- > lunghezza 3 cm
- > 094021 per art. 7212/2/P/E, 7212/3/P/E, 7212/4/P/E
- > 094025 per art. 7212/P/E



GREZZO	
094021	2/3/4 out €
094025	1 out €

PER COMANDI TERMOSTATICI ALTA PORTATA, CONSULTARE SEZIONE REVIVRE DA PAG. 326.

FOR HIGH FLOW RATE THERMOSTATIC MIXER, LOOK AT THE "REVIVRE" COLLECTION FROM PAGE 326.

8812/H/P/E + 774035	8812/2H/P/E + 774036	8812/3H/P/E + 774033	8812/4H/P/E + 774034	8812/H/E + 884036	8812/2H/E + 884037	8812/3H/E + 884038	8812/4H/E + 884039
1 OUT ALTA PORTATA HIGH FLOW RATE	2 OUT ALTA PORTATA HIGH FLOW RATE	3 OUT ALTA PORTATA HIGH FLOW RATE	4 OUT ALTA PORTATA HIGH FLOW RATE	1 OUT ALTA PORTATA HIGH FLOW RATE	2 OUT ALTA PORTATA HIGH FLOW RATE	3 OUT ALTA PORTATA HIGH FLOW RATE	4 OUT ALTA PORTATA HIGH FLOW RATE

7209/1

MISCELATORE DOCCIA ESTERNO
EXTERNAL SHOWER MIXER

- > cartuccia tradizionale
- > senza set doccia
- > attacchi da 1/2"

PILETTA DOCCIA
SHOWER WASTE
8816/E + 775025
p. 888

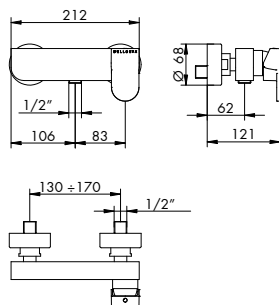

CROMATO	
01-7209/1	€

ALTRE FINITURE	
XX-7209/1	€ x M*

CARTUCCIA
CARTRIDGE
025002

7209/4

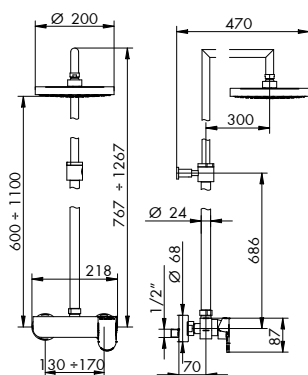
MISCELATORE DOCCIA ESTERNO C/STELO
EXTERNAL SHOWER MIXER WITH PIPE

- > cartuccia tradizionale
- > stelo regolabile
- > soffione ABS Ø200 con anticalcare
- > attacchi da 1/2"
- > per finiture diverse da cromo soffione in metallo

PILETTA DOCCIA
SHOWER WASTE8816/E + 775025
p. 888

CROMATO

01-7209/4

€

ALTRE FINITURE

XX-7209/4

€

x M*

CARTUCCIA
CARTRIDGE

025002

7209/5/1

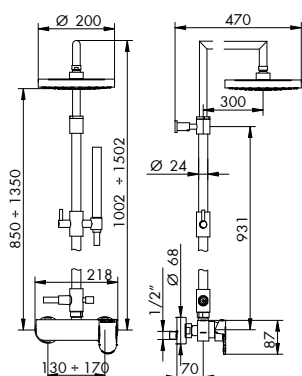
MISCELATORE DOCCIA ESTERNO C/STELO
EXTERNAL SHOWER MIXER WITH PIPE

- > cartuccia tradizionale
- > stelo regolabile
- > deviatore a trazione c/ritorno automatico e blocco meccanico bassa pressione
- > soffione orientabile Ø200 in ABS c/anticalcare
- > flessibile in PVC 150 cm > supporto doccetta scorrevole
- > attacchi da 1/2"
- > doccetta monogetto cilindrica in ABS c/anticalcare
- > per finiture diverse da cromo doccetta e soffione in metallo

PILETTA DOCCIA
SHOWER WASTE8816/E + 775025
p. 888

CROMATO

01-7209/5/1

€

ALTRE FINITURE

XX-7209/5/1

€

x M*

DEVIATORE
DIVERTER

045073

01- cromato / XX- finitura

CARTUCCIA
CARTRIDGE

025002

7211/1A

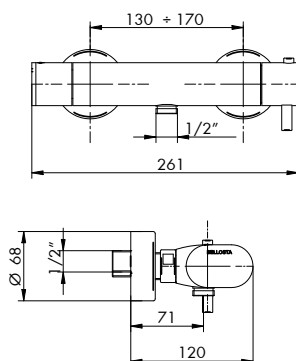
MISCELATORE DOCCIA ESTERNO TERMOSTATICO
EXTERNAL THERMOSTATIC MIXER

- > cartuccia termostatica
- > vitone ceramico 90°
- > senza set doccia
- > attacchi da 1/2"

PILETTA DOCCIA
SHOWER WASTE8816/E + 775025
p. 888

CROMATO

01-7211/1A

€

ALTRE FINITURE

XX-7211/1A

€

x M*

VITONE CERAMICO
CERAMIC VALVE

055002

CART. TERMOSTATICA
THERMOSTATIC
CARTRIDGE

885041

7211/4A

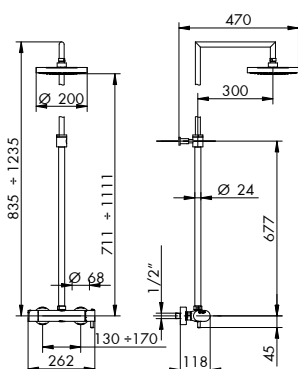
MISCELATORE DOCCIA ESTERNO TERMOSTATICO C/STELO
EXTERNAL THERMOSTATIC MIXER WITH PIPE

- > cartuccia termostatica
- > stelo regolabile
- > soffione orientabile Ø200 in ABS con anticalcare
- > attacchi da 1/2"
- > per finiture diverse da cromo soffione in metallo

PILETTA DOCCIA
SHOWER WASTE8816/E + 775025
p. 888

CROMATO

01-7211/4A

€

ALTRE FINITURE

XX-7211/4A

€

x M*

VITONE CERAMICO
CERAMIC VALVE

055002

CART. TERMOSTATICA
THERMOSTATIC
CARTRIDGE

885041

7211/5A

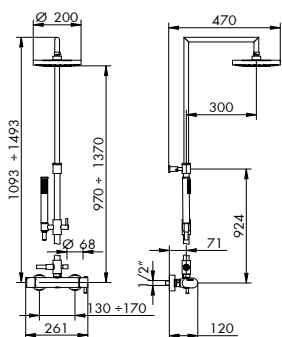

MISCELATORE DOCCIA ESTERNO TERMOSTATICO C/STELO COMPLETO
EXTERNAL THERMOSTATIC MIXER WITH COMPLETE PIPE

- > cartuccia termostatica
- > stelo regolabile
- > deviatore a trazione c/ritorno automatico e blocco meccanico bassa pressione
- > soffione orientabile Ø200 c/anticalcare
- > supporto doccetta scorrevole
- > doccetta monogetto cilindrica in ABS c/anticalcare, per finiture diverse da cromo doccetta in metallo
- > flessibile in PVC 150 cm
- > attacchi da 1/2"



PILETTA DOCCIA
 SHOWER WASTE
8816/E + 775025
 p. 888

CROMATO		ALTRE FINITURE	
01-7211/5A	€	XX-7211/5A	€ x M*



DEVIATORE
 DIVERTER
045073
 01- cromato / XX- finitura



VITONE CERAMICO
 CERAMIC VALVE
055002

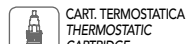

CART. TERMOSTATICA
 THERMOSTATIC
 CARTRIDGE
885041

DOCCIA COMPLEMENTI CONSIGLIATI:
 PER SOLUZIONI ALTERNATIVE E LISTINO PREZZI, CONSULTARE LA SEZIONE COMPLETA, DA PAG. 118.

SUGGESTED "DOCCIA COMPLEMENTI":
 FOR ALTERNATIVE SOLUTIONS AND PRICE LIST, SEE THE COMPLETE COLLECTION FROM PAGE 118.



4403/1/A, 4403/1
 SUPPORTO DOCCIA COMPLETO
 FULL SHOWER SUPPORT



0530N
 SALISCENDI COMPLETO C/PRESA D'ACQUA
 COMPLETE WALL PIPE WITH WATER CONNECTION



0413/4/SP
 STELO DOCCIA
 ROD SHOWER



0413/5/1/SP
 CURVA PRESA ACQUA C/STELO COMPLETO
 CURVE WATER CONNECTOR WITH COMPLETE ROD

SOFFIONI E BRACCI CONSIGLIATI:
 PER SOLUZIONI ALTERNATIVE E LISTINO PREZZI, CONSULTARE LA SEZIONE COMPLETA, DA PAG. 38.
 PER COMPOSIZIONI DOCCIA CONSULTARE SEZIONE REVIVRE.

SUGGESTED "BRACCI E SOFFIONI":
 FOR ALTERNATIVE SOLUTIONS AND PRICE LIST, SEE THE COMPLETE COLLECTION FROM PAGE 38.
 FOR SHOWER TYPESETTING LOOK AT "REVIVRE" COLLECTION.



045230
 SOFFIONE Ø 200 OTTONE
 BRASS CEILING DIAMETER 200



045174
 SOFFIONE Ø 300 OTTONE
 BRASS CEILING DIAMETER 300



884055
 BRACCIO DA PARETE MM 350
 WALL ARM MM 350



044054
 BRACCIO A SOFFITTO MM 250
 CEILING ARM MM 250

COMPONI IL TUO SET DOCCIA:
 PER SOLUZIONI ALTERNATIVE E LISTINO PREZZI, CONSULTARE LA SEZIONE COMPLETA, DA PAG. 186.

DESIGN YOUR SHOWER SET:
 FOR ALTERNATIVE SOLUTIONS AND PRICE LIST, SEE THE COMPLETE COLLECTION FROM PAGE 186.



014083
 GANCIO INCASSO FISSO
 BUILT-IN FIXED HOOK



014084
 SUPPORTO ESTERNO FISSO
 EXTERNAL FIXED SUPPORT



445043 OTTONE
 DOCCETTA MONOGETTO
 MONO JET HAND SHOWER



915001 ABS
 DOCCETTA MONOGETTO
 MONO JET HAND SHOWER



915003
 FLESSIBILE TUBO PVC L150 CM
 PVC TUBE FLEXIBLE L150 CM



655016
 FLESSIBILE TRECCIA OTTONE L150 CM
 BRASS FLEXIBLE L150 CM



0530/1N
 ASTA SALISCENDI
 WALL PIPE

7201/A

MISCELATORE VASCA ESTERNO
EXTERNAL BATH MIXER

- > cartuccia tradizionale
- > interasse bocca 150
- > deviatore a trazione con ritorno manuale a spinta
- > flessibile in PVC 150 cm
- > supporto a parete fisso
- > attacchi da 1/2"
- > doccetta monogetto cilindrica in ABS c/anticalcare, per finiture diverse da cromo doccetta in metallo



012 p. 888

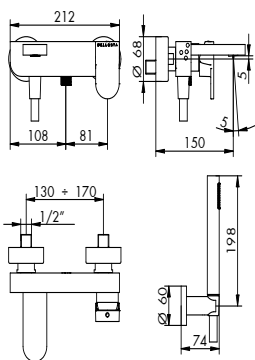

CROMATO		ALTRE FINITURE	
01-7201/A	€	XX-7201/A	€ x M*



725008



724019
01- cromato / XX- finitura



025002

7201/2/A

MISCELATORE PER BORDO VASCA
BATH RIM MIXER

- > cartuccia tradizionale
- > Interasse bocca 106
- > deviatore a pressione c/ritorno automatico e blocco meccanico basse pressioni
- > flessibile in PVC 150 cm > flessibili di alimentazione
- > senza scarico
- > doccetta monogetto cilindrica in ABS c/anticalcare, per finiture diverse da cromo doccetta in metallo
- > OPTIONAL PREDISPOSIZIONI per bordo vasca, art. 012/4, 012/6 e 012/7, pag. 873/874



012 p. 888

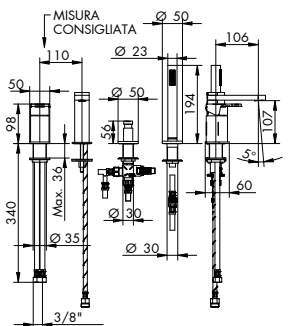

CROMATO		ALTRE FINITURE	
01-7201/2/A	€	XX-7201/2/A	€ x M*



725008



724030



025002

7201/20/A

MISCELATORE PER BORDO VASCA S/BOCCA
BATH RIM MIXER WITHOUT SPOUT

- > cartuccia tradizionale
- > senza bocca
- > deviatore a pressione c/ritorno automatico e blocco meccanico basse pressioni
- > flessibile in PVC 150 cm > flessibili di alimentazione
- > senza scarico
- > doccetta monogetto cilindrica in ABS c/anticalcare, per finiture diverse da cromo doccetta in metallo
- > OPTIONAL PREDISPOSIZIONI per bordo vasca, art. 012/3, 012/6 e 012/7, pag. 873/874



012 p. 888

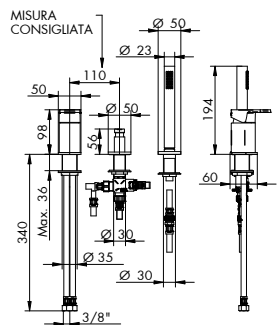

CROMATO		ALTRE FINITURE	
01-7201/20/A	€	XX-7201/20/A	€ x M*



724030



025002

7200/2/P/E + 724028

MISCELATORE INCASSO C/DEVIATORE, DOCCETTA E BOCCA
BUILT-IN MIXER WITH DIVERTER HAND SHOWER AND SPOUT

- > cartuccia tradizionale
- > interasse bocca 153
- > deviatore a pressione 2 uscite c/ritorno automatico e blocco meccanico basse pressioni
- > attacchi da 1/2" > flessibile PVC 150 cm
- > doccetta monogetto cilindrica in ABS c/anticalcare, per finiture diverse da cromo doccetta in metallo



012 p. 888

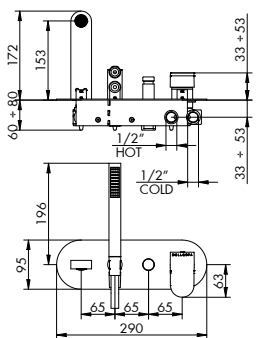

PARTI ESTERNE - CROMATO		PARTI ESTERNE - ALTRE FINITURE	
01-7200/2/P/E	€	XX-7200/2/P/E	€ x M*

PARTE INCASSO	
01-724028	info pag. 39 €

PREZZO TOTALE	€
---------------	---

INCASSO UNIVERSALE



PER INSTALLAZIONI SU PARETI IN CARTONGESSO VERIFICARE LE DIMENSIONI DEL PANNELLO E ORDINARE LA NECESSARIA PROLUNGA
FOR INSTALLATIONS ON DRYWALL, CHECK THE DIMENSIONS OF THE PANEL AND ORDER THE NECESSARY EXTENSION



725008



724030



025002

104006 | 104007 | 104008

KIT PROLUNGA MIX INCASSO CON DEVIAZIONE
BUILT-IN MIXER EXTENSION KIT WITH DIVERTER

- > lunghezza 2 cm, 3 cm, 4 cm
- > kit fondello prolunga cartuccia miscelatore e albero deviatore
- + bicchieri esterni sostitutivi in finitura
- > per art.: 7200/2/P/E



CROMATO		
01-104006	2 cm	€
01-104007	3 cm	€
01-104008	4 cm	€

ALTRE FINITURE			
XX-104006	2 cm	€	x M*
XX-104007	3 cm	€	x M*
XX-104008	4 cm	€	x M*

* **MOLTIPLICATORE RICAMBI**
 * **MULTIPLIER "RICAMBI"**

7203

BOCCA VASCA DA PARETE
WALL BATH SPOUT

- > interasse bocca 166
- > attacchi da 1/2"



012 p. 888

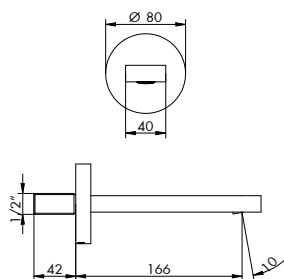

CROMATO	
01-7203	€

ALTRE FINITURE	
XX-7203	€ x M*



725008

044071

SUPPORTO DOCCIA BV TONDO COMPLETO
COMPLETE ROUND HAND SHOWER SET FOR BATH RIM

- > flessibile in PVC 150 cm
- > attacco da 1/2"
- > doccetta monogetto cilindrica in ABS c/anticalcare, per finiture diverse da cromo doccetta in metallo

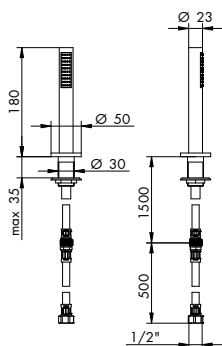

CROMATO	
01-044071	€

ALTRE FINITURE	
XX-044071	€ x M^

^ **MOLTIPLICATORE DOCCIA COMPLEMENTI**
 ^ **MULTIPLIER "DOCCIA COMPLEMENTI"**

7208/E + 054025 DX o 054026 SX

RUBINETTO D'ARRESTO 1/2"
BUILT-IN STOP COCK 1/2"

- > vitone ceramico 90°
- > ingressi da 1/2"

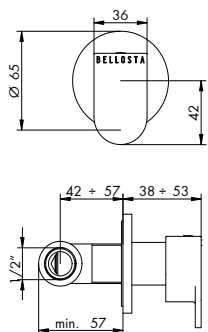

PARTI ESTERNE - CROMATO	
01-7208/E	€
PARTE INCASSO	
054025 o 054026	info pag. 40 €
PREZZO TOTALE	
	€

PARTI ESTERNE - ALTRE FINITURE	
XX-7208/E	€ x M*



VITONE CERAMICO CERAMIC VALVE

055002 SX



VITONE CERAMICO CERAMIC VALVE

055001 DX

7208/E + 054027 DX o 054028 SX

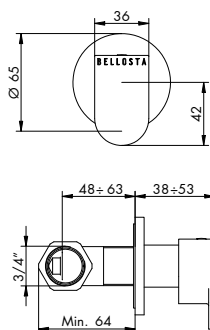
RUBINETTO D'ARRESTO 3/4"
BUILT-IN STOP COCK 3/4"

- > vitone ceramico 90°
- > ingressi da 3/4"

PARTI ESTERNE - CROMATO

01-7208/E €

PARTE INCASSO

054027 o 054028 info pag. 40/41 €

PREZZO TOTALE €

PARTI ESTERNE - ALTRE FINITURE

XX-7208/E € x M*

VITONE CERAMICO
CERAMIC VALVE

055002 SX

VITONE CERAMICO
CERAMIC VALVE

055001 DX

7240/E + 654099

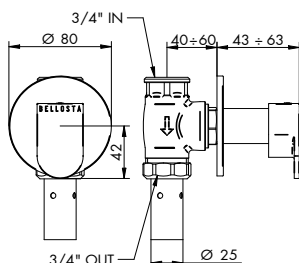
PASSO RAPIDO 3/4"
BUILT-IN RAPID FLOW COCK 3/4"

- > vitone tradizionale
- > abbinare a saracinesca
- > ingressi da 3/4"

PARTI ESTERNE - CROMATO

01-7240/E €

PARTE INCASSO

654099 info pag. 42 €

PREZZO TOTALE €

PARTI ESTERNE - ALTRE FINITURE

XX-7240/E € x M*

VITONE
TRADIZIONALE
TRADITIONAL VALVE

654067

7240/E + 654100

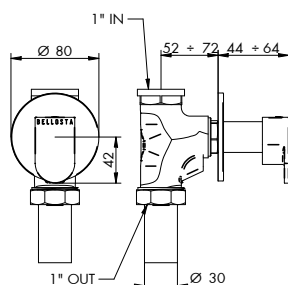
PASSO RAPIDO 1"
BUILT-IN RAPID FLOW COCK 1"

- > vitone tradizionale
- > abbinare a saracinesca
- > ingressi da 1"

PARTI ESTERNE - CROMATO

01-7240/E €

PARTE INCASSO

654100 info pag. 43 €

PREZZO TOTALE €

PARTI ESTERNE - ALTRE FINITURE

XX-7240/E € x M*

VITONE
TRADIZIONALE
TRADITIONAL VALVE

654067

7232/2/E + 035212

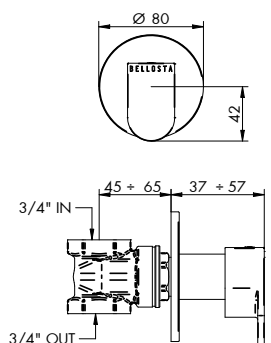
SARACINESCA
GATE VALVE

- > attacchi da 3/4"

PARTI ESTERNE - CROMATO

01-7232/2/E €

PARTE INCASSO

035212 info pag. 43 €

PREZZO TOTALE €

PARTI ESTERNE - ALTRE FINITURE

XX-7232/2/E € x M*



**AERATORI C/CHIAVE
AERATORS AND KEY**

725007 senza finitura

725008 senza finitura



**SNODINO AERATORE
JOINTS WITH AERATOR**

01-014076 cromato

XX-014076 altre finiture



**CARTUCCE
CARTRIDGES**

025002 senza finitura

444021 senza finitura

735005 senza finitura



**DEVIATORI
DIVERTERS**

01-045073 cromato

XX-045073 altre finiture

105029 senza finitura

01-724019 cromato

XX-724019 altre finiture

724030 senza finitura



**CARTUCCE TERMOSTATICHE
THERMOSTATIC CARTRIDGES**

775007 senza finitura

885041 senza finitura



**CARTUCCE DEVIATRICI
DIVERTER CARTRIDGES**

035344 senza finitura

035345 senza finitura

035346 senza finitura

635010 senza finitura

635011 senza finitura

635012 senza finitura



**VITONI CERAMICI
CERAMIC VALVES**

055001 senza finitura

055002 senza finitura

055134 senza finitura



**VITONI TRADIZIONALI
TRADITIONAL VALVES**

654067 senza finitura

ELENCO COMPLETO DISPONIBILE ON LINE: WWW.BELLOSTARUBINETTERIE.COM/ONLINE/RICAMBI.PDF
LISTED COMPLETED AVAILABLE ON LINE: WWW.BELLOSTARUBINETTERIE.COM/ONLINE/RICAMBI.PDF

